

18-36 V Input	50V Transient Input	50V Output	300W Max Power	2250V dc Isolation	Quarter-brick DC-DC Converter
-------------------------	-------------------------------	----------------------	--------------------------	------------------------------	---

The PQ24500QEx06 PowerQor® Exa Quarter-brick converter is a next-generation, board-mountable, isolated, fixed switching frequency DC-DC converter. The Exa series offers industry leading power density for standard isolated DC-DC converters with both a wide input range and a tightly regulated output. This module supplies an isolated step down voltage from 18-36 V to 50V and provides more available power and higher efficiency than competitive converters. RoHS Compliant (see last page).



PQ24500QEx06 Model

Protection Features

- Input under-voltage lockout disables converter at low Vin conditions
- Output current limit
- Short circuit protection
- Protection from permanent damage and hazardous conditions
- Active back bias limit
- Smooth startup with external load induced pre-bias
- Auto-recovery output OVP protects load from damaging voltages
- Thermal shutdown protects converter from abnormal conditions

Mechanical Features

- Industry standard quarter-brick pin-out
- Open frame Size: 1.45" x 2.30" x 0.445" (36.8 x 58.4 x 11.3mm)
- Open frame weight: 1.5 oz (43 g)
- Flanged pins designed to permit surface mount soldering, avoid wave solder using FPIP technique on open frame units

Control Features

- On/Off control referenced to input side
- Positive and negative logic options are available

Safety Features

- CAN/CSA C22.2 No. 60950-1
- UL 60950-1
- EN 60950-1

Operational Features

- High efficiency, 95% at half rated load current
- Delivers 6A full power with minimal derating - no heatsink required
- Operating input voltage range: 18-36 V
- Input voltage transient capability: 50V, 1,000ms
- Fixed frequency switching provides predictable EMI
- No minimum load requirement
- Wide output voltage Trim range (-50% to +10%), see trim section

Contents

	Page No.
Mechanical Information	2
Electrical Characteristics	4
Standards & Qualifications	6
Technical Figures	7
Applications Section	10
Ordering Information	13



Open Frame Mechanical Diagram

Input: 18-36 V
Output: 50V
Current: 6A
Package: Quarter-brick

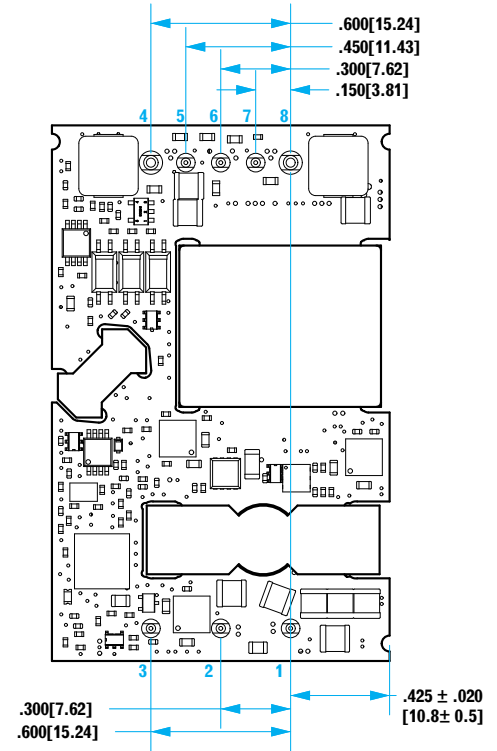
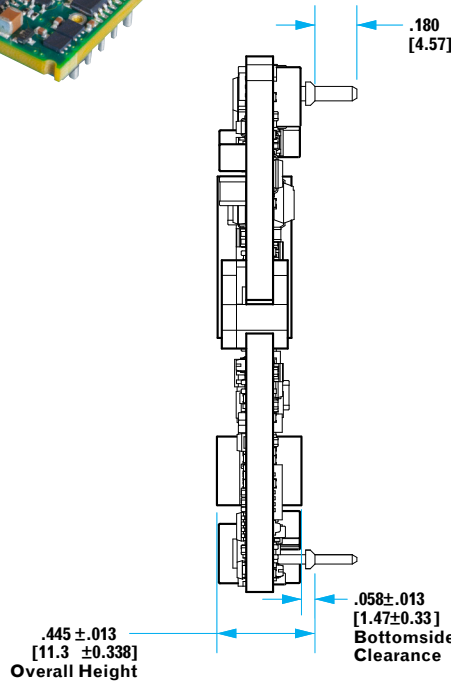
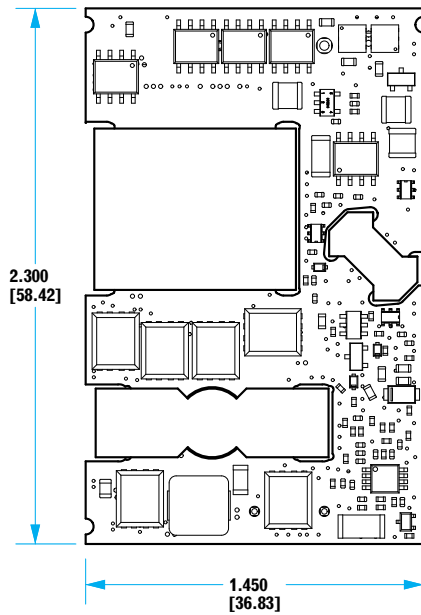
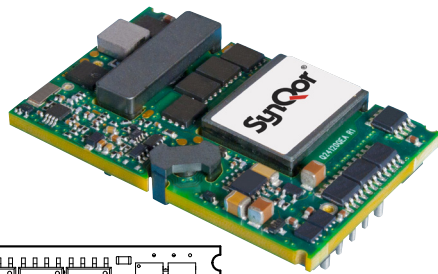

NOTES

- 1) PINS 1-3, 5-7 ARE 0.040" (1.02mm) DIA. WITH 0.080" (2.03mm) DIA. STANDOFF SHOULDERS
- 2) PINS 4 AND 8 ARE 0.062" (1.57mm) DIA. WITH 0.100" (2.54mm) DIA. STANDOFF SHOULDERS
- 3) ALL PINS: MATERIAL: COPPER ALLOY
FINISH: MATTE TIN OVER NICKEL PLATE
- 4) UNDIMENSIONED COMPONENTS ARE SHOWN FOR VISUAL REFERENCE ONLY
- 5) ALL DIMENSIONS IN INCHES(mm)
- 6) TOLERANCES: X.XXIN +/-0.02 (X.Xmm +/-0.5mm)
X.XXXIN +/-0.010 (X.XXmm +/-0.25mm)
- 7) WEIGHT: 1.5 oz (43 g) TYPICAL
- 8) WORKMANSHIP: MEETS OR EXCEEDS IPC-A-610 CLASS II

PIN DESIGNATIONS

Pin	Label	Function
1	Vin(+)	Positive input
2	ON/OFF	TTL input to turn converter on and off, referenced to Vin(-), with internal pull up
3	Vin(-)	Negative input voltage
4	Vout(-)	Negative output voltage
5	SENSE (-)	Negative remote sense. See note 1
6	TRIM	Output voltage trim. See note 2
7	SENSE (+)	Positive remote sense. See note 3
8	Vout(+)	Positive output voltage

Notes:

- 1) SENSE(-) should be connected to Vout(-) either remotely or at the converter.
- 2) Leave TRIM pin open for nominal output voltage.
- 3) SENSE(+) should be connected to Vout(+) either remotely or at the converter.



Baseplated Mechanical Diagram

Input: 18-36 V
Output: 50V
Current: 6A
Package: Quarter-brick

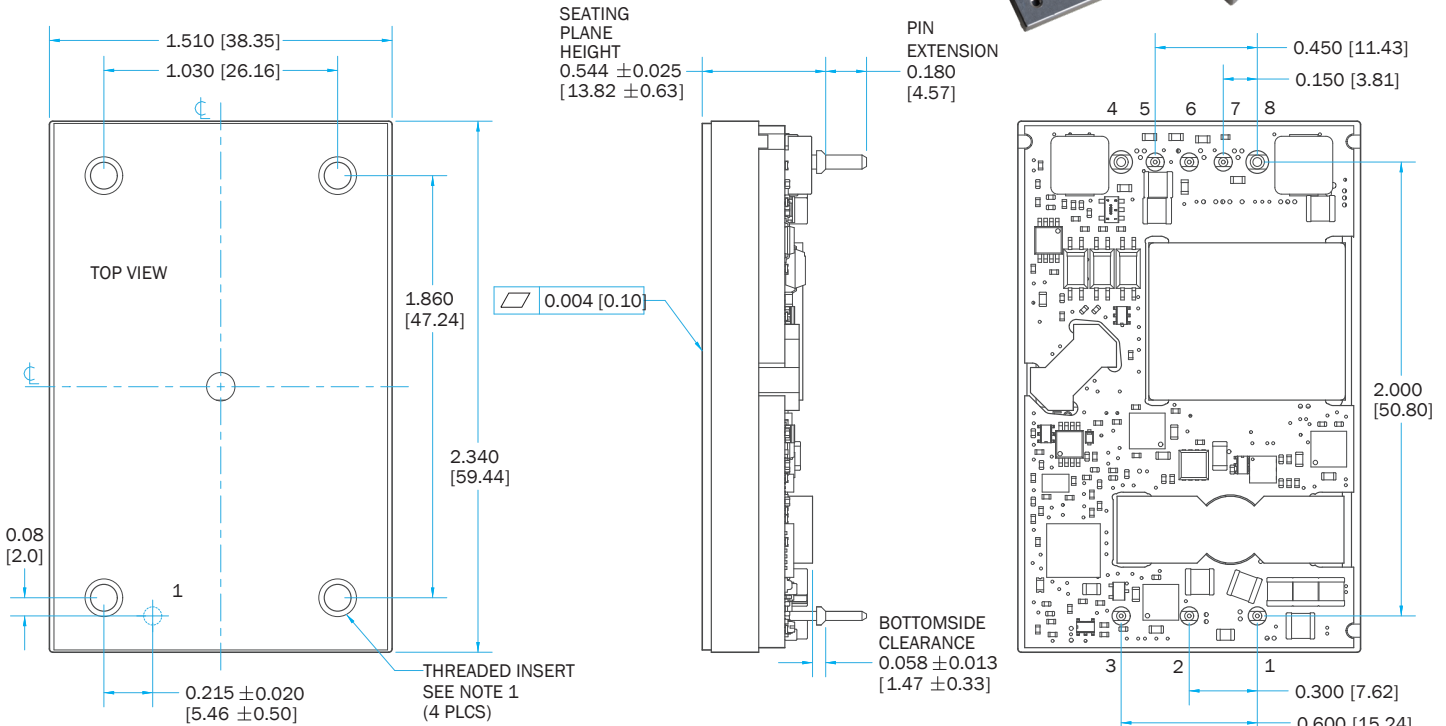

NOTES

- 1) APPLIED TORQUE PER M3 SCREW 4in-lb RECOMMENDED (5in-lb LIMIT) SCREW SHOULD NOT EXCEED 0.100" (2.54mm) DEPTH BELOW THE SURFACE OF THE BASEPLATE.
- 2) BASEPLATE FLATNESS TOLERANCE IS 0.004" (.10mm) TIR FOR SURFACE.
- 3) PINS 1-3, 5-7 ARE 0.040" (1.02mm) DIA. WITH 0.080" (2.03mm) DIA. STANDOFFS.
- 4) PINS 4 AND 8 ARE 0.080" (2.03mm) DIA. WITH 0.125" (3.18mm) DIA. STANDOFFS.
- 5) ALL PINS: MATERIAL: COPPER ALLOY
FINISH: MATTE TIN OVER NICKEL PLATE
- 6) WEIGHT: 3.0 oz (85 g) TYPICAL
- 7) ALL DIMENSIONS IN INCHES(mm)
TOLERANCES: X.XXIN +/-0.02 (X.Xmm +/-0.5mm)
X.XXXIN +/-0.010 (X.XXmm +/-0.25mm)

PIN DESIGNATIONS

Pin	Label	Function
1	Vin(+)	Positive input
2	ON/OFF	TTL input to turn converter on and off, referenced to Vin(-), with internal pull up
3	Vin(-)	Negative input voltage
4	Vout(-)	Negative output voltage
5	SENSE (-)	Negative remote sense. See note 1
6	TRIM	Output voltage trim. See note 2
7	SENSE (+)	Positive remote sense. See note 3
8	Vout(+)	Positive output voltage

Notes:

- 1) SENSE(-) should be connected to Vout(-) either remotely or at the converter.
- 2) Leave TRIM pin open for nominal output voltage.
- 3) SENSE(+) should be connected to Vout(+) either remotely or at the converter.



Technical Specifications

Input: 18-36 V
Output: 50V
Current: 6A
Package: Quarter-brick

PQ24500QEx06 Electrical Characteristics

Ta = 25 °C, airflow rate = 300 LFM, Vin = 24V dc unless otherwise noted; full operating temperature range is -40 °C to +100 °C ambient temperature with appropriate power derating. Specifications subject to change without notice.

Parameter	Min.	Typ.	Max.	Units	Notes & Conditions
ABSOLUTE MAXIMUM RATINGS					
Input Voltage					
Non-Operating	-1		50	V	Continuous
Operating			40	V	Continuous
Operating Transient Protection			50	V	1 s transient, square wave
Insulation Voltage					
Input to Output			2250	V dc	
Operating Temperature	-40		100	°C	
Storage Temperature	-45		125	°C	
Voltage at ON/OFF input pin	-2		9	V	
INPUT CHARACTERISTICS					
Operating Input Voltage Range	18	24	36	V	
Input Under-Voltage Lockout					
Turn-On Voltage Threshold	16.2	17.0	17.9	V	
Turn-Off Voltage Threshold	14.7	15.5	16.3	V	
Lockout Voltage Hysteresis		1.5		V	
Maximum Input Current			20	A	100% Load, 18V Vin, Trimmed up 10%
No-Load Input Current		200	250	mA	
Disabled Input Current		4	6	mA	
Response to Input Transient		5		V	0.25V/μs input transient
Input Reflected Ripple Current		4		mA	RMS thru 4.7μH inductor
Input Terminal Ripple Current		250		mA	RMS
Recommended Input Fuse			30	A	Fast acting external fuse recommended
Recommended External Input Capacitance		470		μF	Typical ESR 0.1-0.2Ω; Figure 13
Input Filter Component Values (C1, L1, C2)		0.1\0.22\28.3		μF\μH\μF	Internal values; see Figure D
OUTPUT CHARACTERISTICS					
Output Voltage Set Point	49.50	50.00	50.50	V	
Output Voltage Regulation					
Over Line		±1.0\500		%\mV	Typical. See Note 1
Over Load		±1.0\500		%\mV	Typical. See Note 1
Over Temperature	-800		800	mV	
Total Output Voltage Range	48.50		51.50	V	Over sample, line, load, temperature & life
Output Voltage Ripple and Noise					20MHz bandwidth; see Note 2
Peak-to-Peak		120		mV	100% Load
RMS		25		mV	100% Load
Operating Output Current Range	0		6	A	Subject to thermal derating
Output DC Current-Limit Inception	6.6	7.2	8.4	A	Output Voltage 10% Low
Output DC Current-Limit Shutdown Voltage		18		V	
Back-Drive Current Limit while Enabled		2		A	Negative current drawn from output
Back-Drive Current Limit while Disabled		3	4	mA	Negative current drawn from output
Maximum Output Capacitance Electrolytic			500	μF	Nominal Vout at 100% load (resistive load)
EFFICIENCY					
100% Load		95		%	Figures 1 - 2
50% Load		95		%	Figures 1 - 2

PQ24500QEx06 Electrical Characteristics (continued)

Ta = 25 °C, airflow rate = 300 LFM, Vin = 24V dc unless otherwise noted; full operating temperature range is -40 °C to +100 °C ambient temperature with appropriate power derating. Specifications subject to change without notice.

Parameter	Min.	Typ.	Max.	Units	Notes & Conditions
DYNAMIC CHARACTERISTICS					
Output Voltage during Load Current Transient					
Step Change in Output Current (0.1A/μs)		1000		mV	50% to 75% to 50% Iout max
Step Change in Output Current (1A/μs)		750		mV	50% to 75% to 50% Iout max
Settling time		0.25		ms	To within 1% Vout nom
Turn-On Transient					
Turn-On Time		35		ms	Full load, Vout=90% nom; Figures 9 & 10
Output Voltage Overshoot			2	%	Maximum Output Capacitance
ISOLATION CHARACTERISTICS					
Isolation Voltage (dielectric strength)		2250		V	See Absolute Maximum Ratings
Isolation Resistance	30			MΩ	
Isolation Capacitance (input to output)		1000		pF	See Note 3
TEMPERATURE LIMITS FOR POWER DERATING CURVES					
Semiconductor Junction Temperature			125	°C	Package rated to 150°C
Board Temperature			125	°C	UL rated max operating temp 130°C
Transformer Temperature			125	°C	
FEATURE CHARACTERISTICS					
Switching Frequency Regulation Stage	230	240	250	kHz	
Switching Frequency Isolation Stage	115	120	125	kHz	
ON/OFF Control (Option P)					
Off-State Voltage	-2.0		0.8	V	
On-State Voltage	2.4		9.0	V	
ON/OFF Control (Option N)					
Off-State Voltage	2.4		9.0	V	
On-State Voltage	-2.0		0.8	V	
ON/OFF Control (Either Option)					Application notes; Figure A
Pull-Up Voltage	4.75	5.00	5.25	V	
Pull-Up Resistance		20		kΩ	
Output Voltage Trim Range	-50		10	%	Measured across Pins 8 & 4; Figure B
Output Over-Voltage Protection	111	114	119	%	Over Full Temperature Range; % of nominal Vout
Over-Temperature Shutdown		120		°C	Average PCB Temperature
Over-Temperature Shutdown Restart Hysteresis		10		°C	
RELIABILITY CHARACTERISTICS					
Calculated MTBF (Telcordia) SR-332, Issue 2		3.5		10 ⁶ Hrs.	TR-NWT-000332; 80% load, 300LFM, 40°C Ta
Calculated MTBF (MIL-217) MIL-HDBK-217F		2.7		10 ⁶ Hrs.	MIL-HDBK-217F; 80% load, 300LFM, 40°C Ta
Field Demonstrated MTBF				10 ⁶ Hrs.	See our website for details

Note 1: Line and load regulation is limited by duty cycle quantization and does not indicate a shift in the internal voltage reference.

Note 2: For applications requiring reduced output voltage ripple and noise, consult SynQor applications support (e-mail: support@synqor.com)

Note 3: Higher values of isolation capacitance can be added external to the module.



Technical Specifications

Input: 18-36 V
Output: 50V
Current: 6A
Package: Quarter-brick

Standards Compliance & Qualification Testing

Parameter	Notes & Conditions
STANDARDS COMPLIANCE	
CAN/CSA C22.2 No. 60950-1	
UL 60950-1	
EN 60950-1	

Note: An external input fuse must always be used to meet these safety requirements. Contact SynQor for official safety certificates on new releases or download from the SynQor website.

Parameter	# Units	Test Conditions
QUALIFICATION TESTING		
Life Test	32	95% rated Vin and load, units at derating point, 1000 hours
Vibration	5	10-55 Hz sweep, 0.060" total excursion, 1 min./sweep, 120 sweeps for 3 axis
Mechanical Shock	5	100 g minimum, 2 drops in x, y and z axis
Temperature Cycling	10	-40 °C to 100 °C, unit temp. ramp 15 °C/min., 500 cycles
Power/Thermal Cycling	5	Toperating = min to max, Vin = min to max, full load, 100 cycles
Design Marginality	5	Tmin-10 °C to Tmax+10 °C, 5 °C steps, Vin = min to max, 0-105% load
Humidity	5	85 °C, 85% RH, 1000 hours, continuous Vin applied except 5 min/day
Solderability	15 pins	MIL-STD-883, method 2003

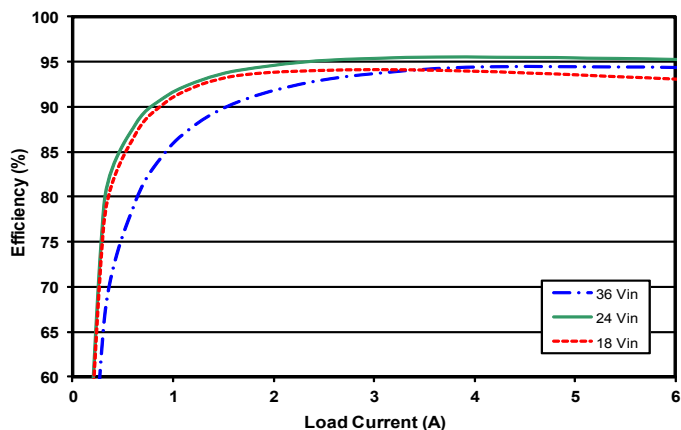

Figure 1: Efficiency at nominal output voltage vs. load current for minimum, nominal, and maximum input voltage at 25°C.

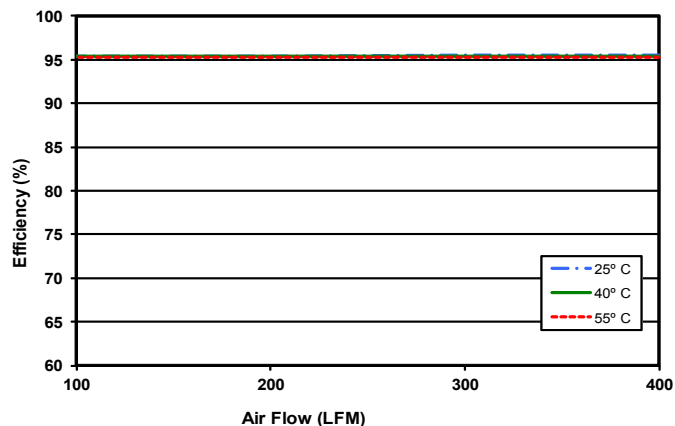

Figure 2: Efficiency at nominal output voltage and 60% rated power vs. airflow rate for ambient air temperatures of 25°C, 40°C, and 55°C (nominal input voltage).

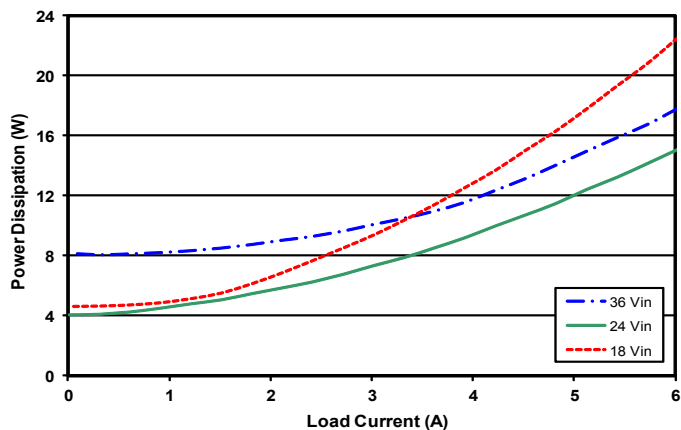

Figure 3: Power Dissipation at nominal output voltage vs. load current for minimum, nominal, and maximum input voltage at 25°C.

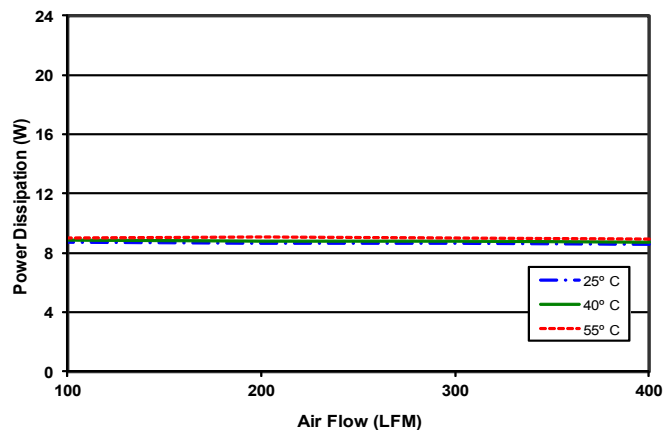

Figure 4: Power Dissipation at nominal output voltage and 60% rated power vs. airflow rate for ambient air temperatures of 25°C, 40°C, and 55°C (nominal input voltage).

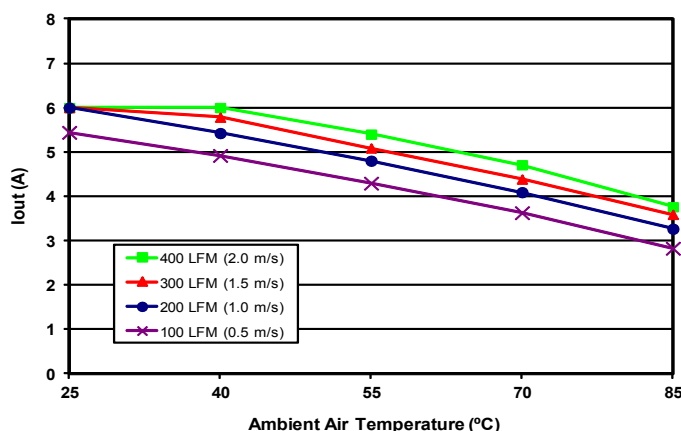

Figure 5: Thermal Derating (max output current vs. ambient air temperature) for airflow rates of 100 LFM through 400 LFM with air flowing from pin 3 to pin 1 (nominal input voltage).

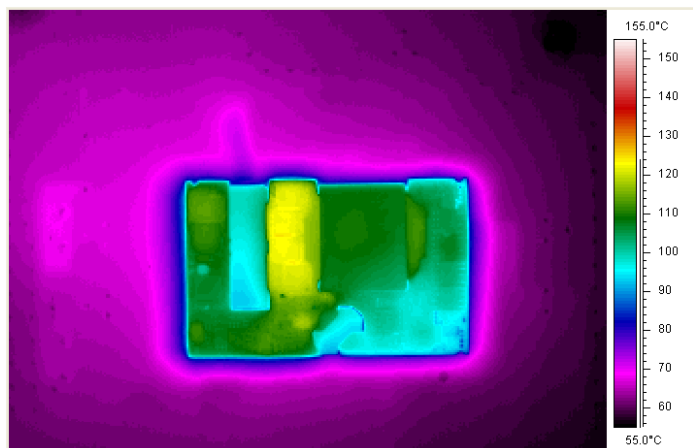

Figure 6: Thermal Image of converter at 4.8 amp load current (240W) with 55°C air flowing at the rate of 200 LFM. Air is flowing from pin 3 to pin 1 (nominal input voltage).

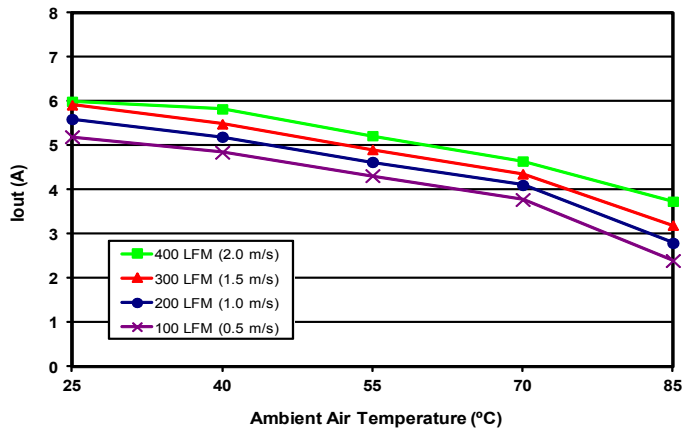

Figure 7: Thermal Derating (max output current vs. ambient air temperature) for airflow rates of 100 LFM through 400 LFM with air flowing lengthwise from input to output (nominal input voltage).

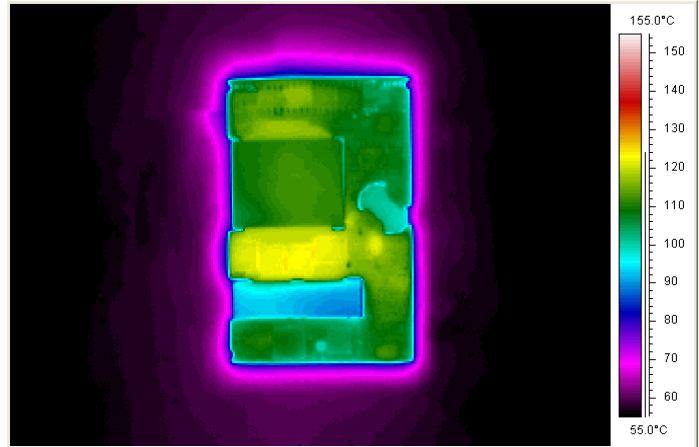

Figure 8: Thermal Image of converter at 4.6 amp load current (230W) with 55°C air flowing at the rate of 200 LFM. Air is flowing across the converter from input to output (nominal input voltage).

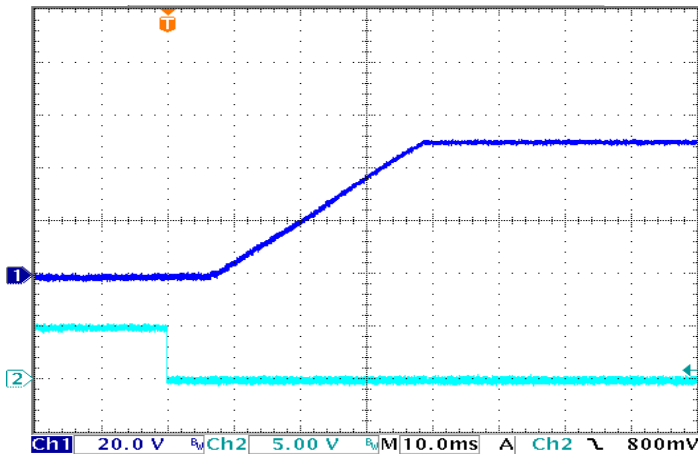

Figure 9: Turn-on Transient at full load (resistive load) (10 ms/div). Input voltage pre-applied. Top Trace: Vout (20V/div). Bottom Trace: ON/OFF input (5V/div)

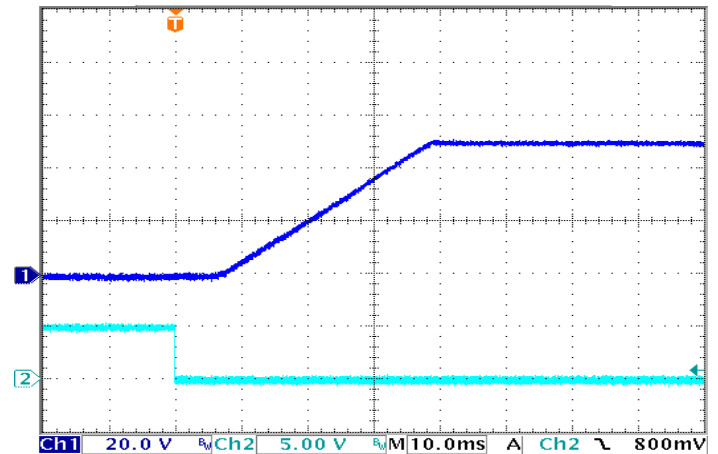

Figure 10: Turn-on Transient at zero load (10 ms/div). Top Trace: Vout (20V/div). Bottom Trace: ON/OFF input (5V/div)

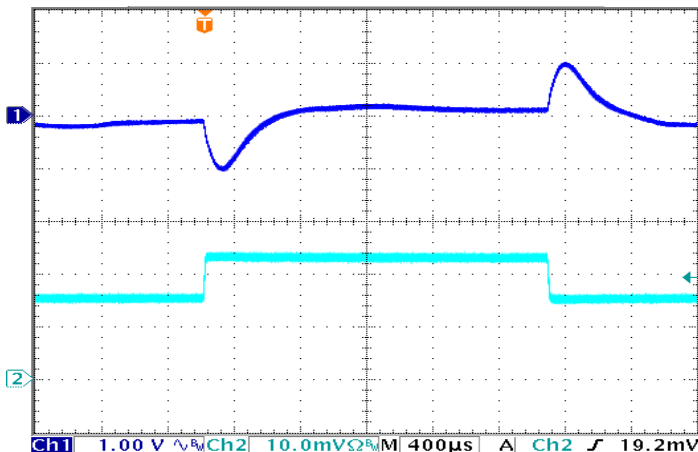

Figure 11: Output Voltage Response to Step-Change in Load Current (50%-75%-50% of $I_{out(max)}$; $dI/dt = 0.1A/\mu s$). Load cap: 100 μF electrolytic output capacitance. Top trace: Vout (1V/div). Bottom trace: Iout (2A/div).

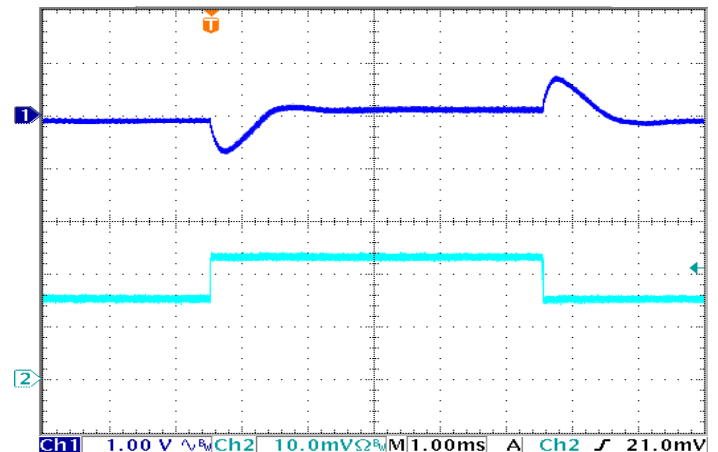

Figure 12: Output Voltage Response to Step-Change in Load Current (50%-75%-50% of $I_{out(max)}$; $dI/dt = 1A/\mu s$). Load cap: 330 μF electrolytic output capacitance. Top trace: Vout (1V/div). Bottom trace: Iout (2A/div).

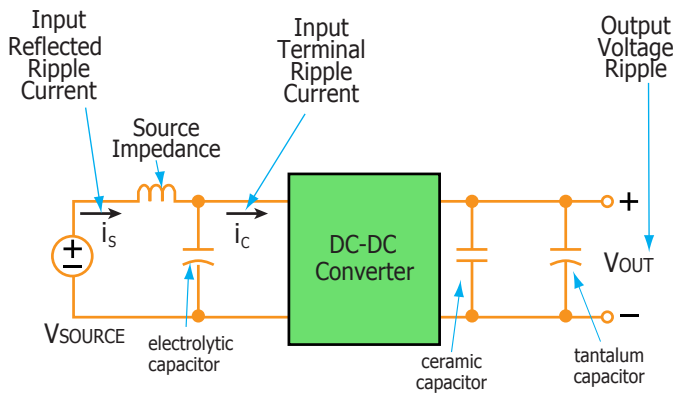

Figure 13: Test Set-up Diagram showing measurement points for Input Terminal Ripple Current (Figure 14), Input Reflected Ripple Current (Figure 15) and Output Voltage Ripple (Figure 16).

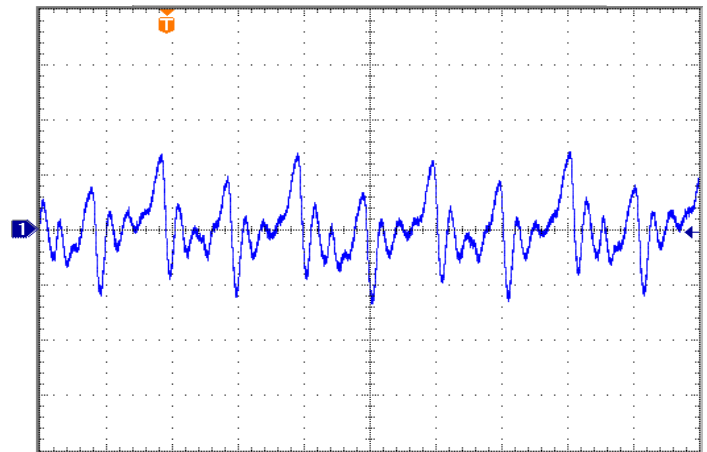

Figure 14: Input Terminal Ripple Current, i_c , at full rated output current and nominal input voltage with $4.7\mu H$ source impedance and $470\mu F$ electrolytic capacitor (Ch.1 500mA/div). (See Figure 13).

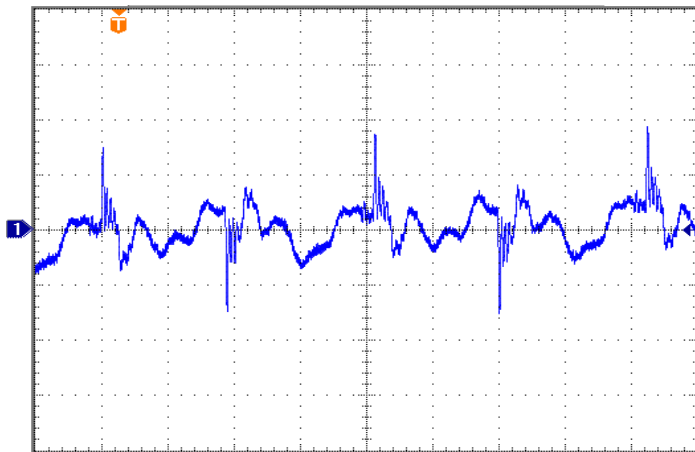

Figure 15: Input Reflected Ripple Current, i_s , through a $4.7\mu H$ source inductor at nominal input voltage and rated load current (10 mA/div). (See Figure 13).

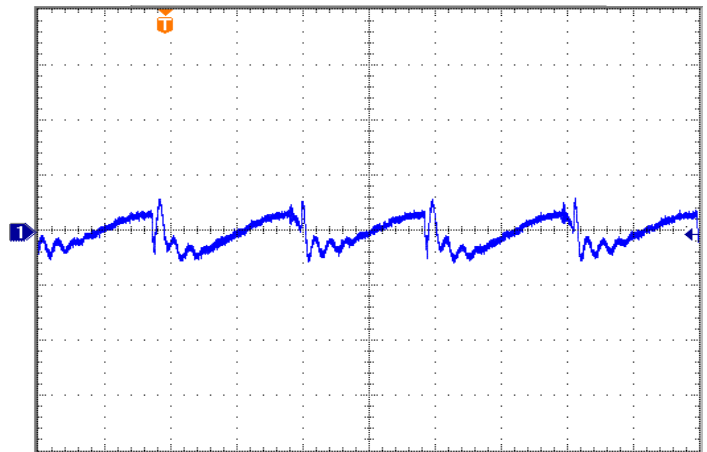

Figure 16: Output Ripple at nominal input voltage and rated load current (100 mV/div). Load capacitance: one $1.0\mu F$ ceramic capacitor and one $100\mu F$ electrolytic capacitor. Bandwidth: 20 MHz. (See Figure 13).

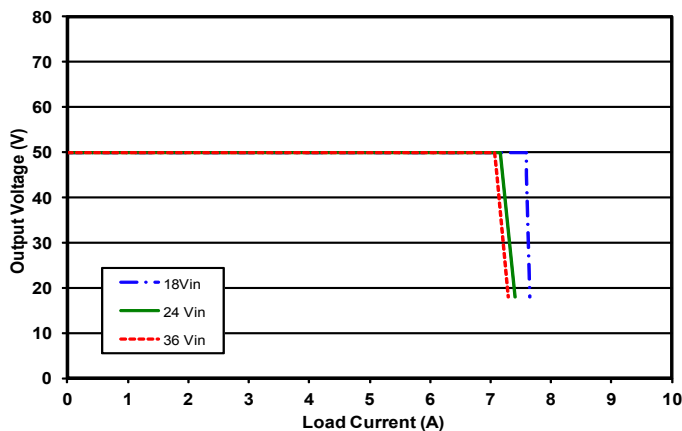

Figure 17: Output I-V Characteristics (output voltage vs load current) showing typical current limit curves and converter shutdown points.

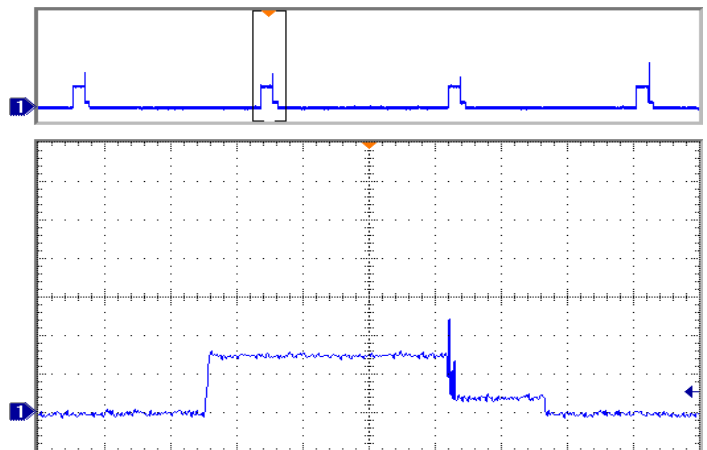

Figure 18: Output Short Load Current (5A/div) as a function of time when the converter attempts to turn on into a $1 m\Omega$ short circuit. Top trace (200ms/div) is an expansion of the on-time portion of the bottom trace.

BASIC OPERATION AND FEATURES

This converter series uses a two-stage power conversion topology. The first stage keeps the output voltage constant over variations in line, load, and temperature. The second stage uses a transformer to provide the functions of input/output isolation and voltage step-down to achieve the low output voltage required.

Both the first stage and the second stage switch at a fixed frequency for predictable EMI performance. Rectification of the transformer's output is accomplished with synchronous rectifiers. These devices, which are MOSFETs with a very low on-state resistance, dissipate significantly less energy than Schottky diodes, enabling the converter to achieve high efficiency.

Dissipation throughout the converter is so low that it does not require a heatsink for operation in many applications; however, adding a heatsink provides improved thermal derating performance in extreme situations. To further withstand harsh environments and thermally demanding applications, certain models are available baseplated or totally encased. See Ordering Information page for available thermal design options.

SynQor quarter-brick converters use the industry standard footprint and pin-out.

CONTROL FEATURES

REMOTE ON/OFF (Pin 2): The ON/OFF input, Pin 2, permits the user to control when the converter is on or off. This input is referenced to the return terminal of the input bus, Vin(-).

In negative logic versions, the ON/OFF signal is active low (meaning that a low voltage turns the converter on). In positive logic versions, the ON/OFF input is active high (meaning that a high voltage turns the converter on). Fig A details possible circuits for driving the ON/OFF pin. See Ordering Information page for available enable logics.

REMOTE SENSE Pins 7(+) and 5(-): The SENSE(+) and SENSE(-) inputs correct for voltage drops along the conductors that connect the converter's output pins to the load.

Pin 7 should connect to Vout(+) and Pin 5 should connect to Vout(-) at the point on the board where regulation is desired. If these connections are not made, the converter will deliver an output voltage that is slightly higher than its specified value.

Note: the output over-voltage protection circuit senses the voltage across the output (pins 8 and 4) to determine when it should trigger, not the voltage across the converter's sense leads (pins 7 and 5). Therefore, the resistive drop on the board should be small enough so that output OVP does not trigger, even during load transients.

OUTPUT VOLTAGE TRIM (Pin 6): The TRIM input permits the user to adjust the output voltage across the sense leads up or down according to the trim range specifications. SynQor uses industry standard trim equations.

To decrease the output voltage, the user should connect a resistor between Pin 6 (TRIM) and Pin 5 (SENSE(-) input). For a desired decrease of the nominal output voltage, the value of the resistor should be:

$$R_{\text{trim-down}} = \left(\frac{511\%}{\Delta\%} - 10.22 \right) \text{ k}\Omega$$

where

$$\Delta\% = \left| \frac{V_{\text{nominal}} - V_{\text{desired}}}{V_{\text{nominal}}} \right| \times 100\%$$

To increase the output voltage, the user should connect a resistor between Pin 6 (TRIM) and Pin 7 (SENSE(+) input). For a desired increase of the nominal output voltage, the value of the resistor should be:

$$R_{\text{trim-up}} = 5.11 \left[\frac{\left(\frac{V_{\text{nominal}}}{1.225} - 2 \right) \times V_{\text{desired}} + V_{\text{nominal}}}{V_{\text{desired}} - V_{\text{nominal}}} \right] \text{ k}\Omega$$

The Trim Graph in Figure B shows the relationship between the trim resistor value and Rtrim-up and Rtrim-down, showing the total range the output voltage can be trimmed up or down.

Note: The TRIM feature does not affect the voltage at which the output over-voltage protection circuit is triggered. Trimming the output voltage too high may cause the over-voltage protection circuit to engage, particularly during transients.

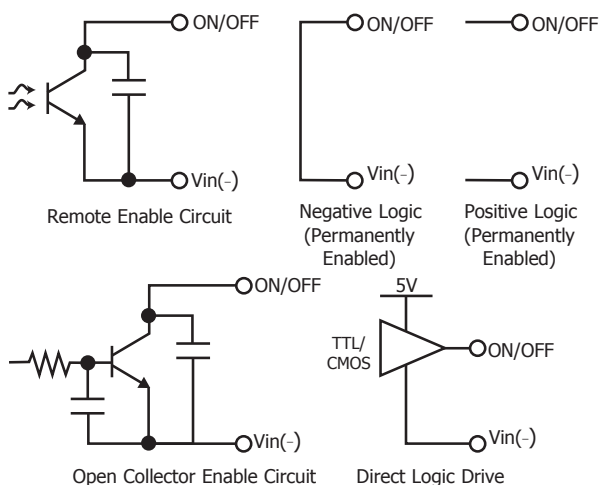

Figure A: Various Circuits for Driving the ON/OFF Pin.

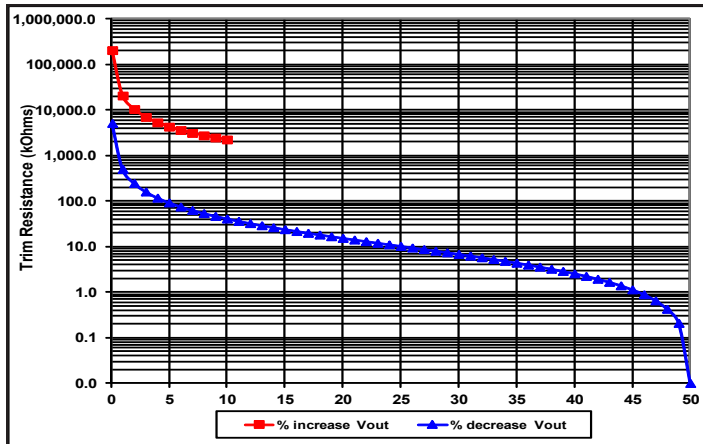

Figure B: Trim Graph.

It is not necessary for the user to add capacitance at the TRIM pin. The node is internally filtered to eliminate noise.

Total DC Variation of Vout: For the converter to meet its full specifications, the maximum variation of the DC value of Vout, due to both trimming and remote load voltage drops, should not be greater than that specified for the output voltage trim range.

PROTECTION FEATURES

Input Under-Voltage Lockout (UVLO): The converter is designed to turn off when the input voltage is too low, helping to avoid an input system instability problem, which is described in more detail in the application note titled "Input System Instability" on the SynQor website. When the input is rising, it must exceed the typical "Turn-On Voltage Threshold"* before the converter will turn on. Once the converter is on, the input must fall below the typical "Turn-Off Voltage Threshold"* before the converter will turn off.

Output Current Limit (OCP): If the output current exceeds the "Output DC Current Limit Inception" value*, then a fast linear current limit controller will reduce the output voltage to maintain a constant output current. If as a result, the output voltage falls below the "Output DC Current Limit Shutdown Voltage"* for more than 50 ms, then the unit will enter into hiccup mode, with a 500 ms off-time. The unit will then automatically attempt to restart.

Back-Drive Current Limit: If there is negative output current of a magnitude larger than the "Back-Drive Current Limit while Enabled" specification*, then a fast back-drive limit controller will increase the output voltage to maintain a constant output current. If this results in the output voltage exceeding the "Output Over-Voltage Protection" threshold*, then the unit will shut down.

Output Over-Voltage Limit (OVP): If the voltage across the output pins exceeds the "Output Over-Voltage Protection" threshold*, the converter will immediately stop switching. This prevents damage to the load circuit due to 1) excessive series resistance in output current path from converter output pins to sense point, 2) a release of a short-circuit condition, or 3) a release of a current limit condition. Load capacitance determines exactly how high the output voltage will rise in response to these conditions. After 500 ms the converter will automatically restart for all but the S Feature Set option, which is latching and will not restart until input power is cycled or the ON/OFF input is toggled.

During an output over-voltage condition, the converter's LED will illuminate. For units with latching OVP (S Feature Set), once the over-voltage condition has been removed the LED will flash steadily until the input power or the ON/OFF input is toggled.

Over-Temperature Shutdown (OTP): A thermister on the converter senses the average temperature of the module. The thermal shutdown circuit is designed to turn the converter off when the temperature at the sensed location reaches the "Over-Temperature Shutdown" value*. It will allow the converter to turn on again when the temperature of the sensed location falls by the amount of the "Over-Temperature Shutdown Restart Hysteresis"*.

Startup Inhibit Period: The Startup Inhibit Period ensures that the converter will remain off for approximately 500 ms when it is shut down due to a fault. This generates a 2 Hz "hiccup mode," preventing the converter from overheating. There are multiple ways the converter can be shut down, initiating a Startup Inhibit Period:

- Output Over-Voltage Protection
- Current Limit
- Short Circuit Protection
- Disabling via ON/OFF input (excluding PQ60120QE & PQ60120QZ)

* See Electrical Characteristics section.

APPLICATION CONSIDERATIONS

Input System Instability: This condition can occur because any DC-DC converter appears incrementally as a negative resistance load. A detailed application note titled "Input System Instability" is available on the SynQor website which provides an understanding of why this instability arises, and shows the preferred solution for correcting it.

Application Circuits: A typical circuit diagram, Figure C below details the input filtering and voltage trimming.

Input Filtering and External Input Capacitance: Figure D below shows the internal input filter components. This filter dramatically reduces input terminal ripple current, which otherwise could exceed the rating of an external electrolytic input capacitor. The recommended external input capacitance is specified in the Input Characteristics section of the Electrical Specifications. More detailed information is available in the application note titled "EMI Characteristics" on the SynQor website.

Output Filtering and External Output Capacitance: The internal output filter components are shown in Figure D below. This filter dramatically reduces output voltage ripple. Some minimum external output capacitance is required, as specified in the Output Characteristics area of the Electrical Characteristics section. No damage will occur without this capacitor connected, but peak output voltage ripple will be much higher.

Thermal Considerations: For baseplated and encased versions, the max operating baseplate temperature, T_B , is 100 °C. Refer to the Thermal Derating Curves in the Technical Figures section to see the available output current at baseplate temperatures below 100 °C.

A power derating curve can be calculated for any heatsink that is attached to the base-plate of the converter. It is only necessary to determine the thermal resistance, R_{THBA} , of the chosen heatsink between the baseplate and the ambient air for a given airflow rate. This information is usually available from the heatsink vendor. The following formula can be used to determine the maximum power the converter can dissipate for a given thermal condition if its base-plate is to be no higher than 100 °C.

$$P_{diss}^{max} = \frac{100\text{ °C} - T_A}{R_{THBA}}$$

This value of maximum power dissipation can then be used in conjunction with the data shown in the Power Dissipation Curves in the Technical Figures section to determine the maximum load current (and power) that the converter can deliver in the given thermal condition.

For convenience, Thermal Derating Curves are provided in the Technical Figures section.

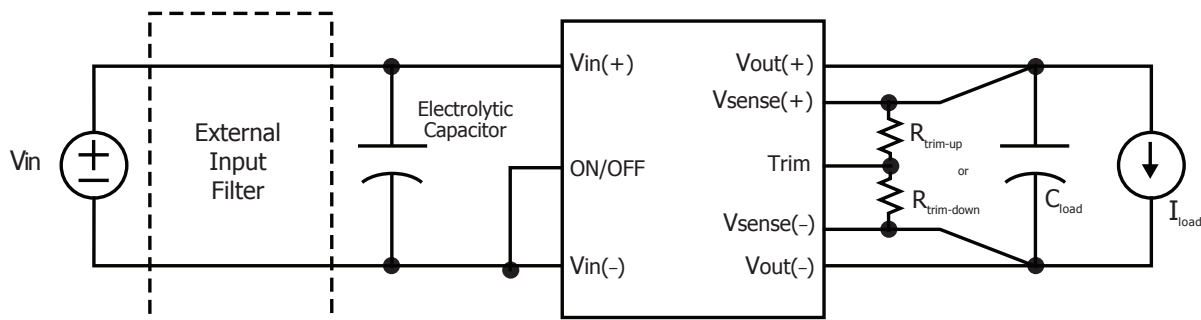

Figure C: Typical Application Circuit (negative logic unit, permanently enabled).

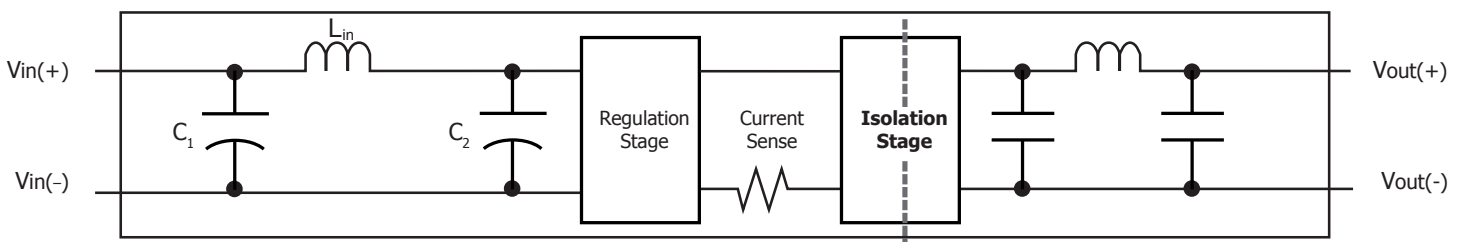
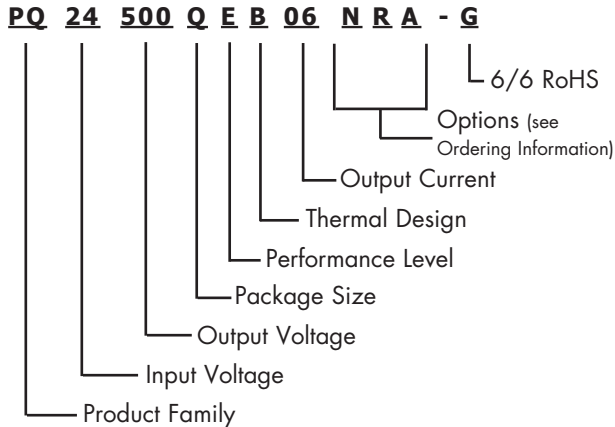

Figure D: Internal Input and Output Filter Diagram (component values listed in Electrical Characteristics section).

Part Numbering System

The part numbering system for SynQor's dc-dc converters follows the format shown in the example below.



The first 12 characters comprise the base part number and the last 3 characters indicate available options. The "-G" suffix indicates 6/6 RoHS compliance.

Application Notes

A variety of application notes and technical white papers can be downloaded in pdf format from our [website](#).

RoHS Compliance: The EU led RoHS (Restriction of Hazardous Substances) Directive bans the use of Lead, Cadmium, Hexavalent Chromium, Mercury, Polybrominated Biphenyls (PBB), and Polybrominated Diphenyl Ether (PBDE) in Electrical and Electronic Equipment. This SynQor product is 6/6 RoHS compliant. For more information please refer to SynQor's RoHS addendum available at our [RoHS Compliance / Lead Free Initiative web page](#) or e-mail us at rohs@synqor.com.

Contact SynQor for further information and to order:

Phone: 978-849-0600 Toll Free: 888-567-9596 Fax: 978-849-0602

E-mail: power@synqor.com Web: www.synqor.com

Address: 155 Swanson Road, Boxborough, MA 01719 USA

WARRANTY

SynQor offers a three (3) year limited warranty. Complete warranty information is listed on our website or is available upon request from SynQor.

Ordering Information

The tables below show the valid model numbers and ordering options for converters in this product family. When ordering SynQor converters, please ensure that you use the complete 15 character part number consisting of the 12 character base part number and the additional characters for options. Add "-G" to the model number for 6/6 RoHS compliance.

Model Number	Input Voltage	Output Voltage	Max Output Current
PQ24500QEx06xyz-G	18-36 V	50V	6A

The following options must be included in place of the **wxyz** spaces in the model numbers listed above.

Options Description: wxyz			
Thermal Design	Enable Logic	Pin Style	Feature Set
A - Open Frame B - Baseplated	N - Negative P - Positive	K - 0.110" N - 0.145" R - 0.180" Y - 0.250"	A - Standard

Not all combinations make valid part numbers, please contact SynQor for availability. See the web site for more options.

PATENTS

SynQor holds numerous U.S. patents, one or more of which apply to most of its power conversion products. Any that apply to the product(s) listed in this document are identified by markings on the product(s) or on internal components of the product(s) in accordance with U.S. patent laws. SynQor's patents include the following:

6,896,526	6,927,987	7,050,309	7,765,687
7,787,261	8,149,597	8,644,027	